

## Objekt

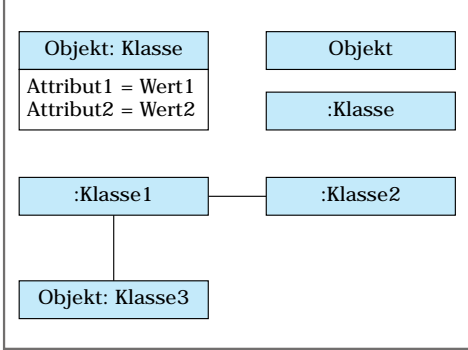

## Klasse

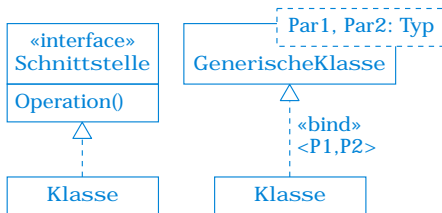
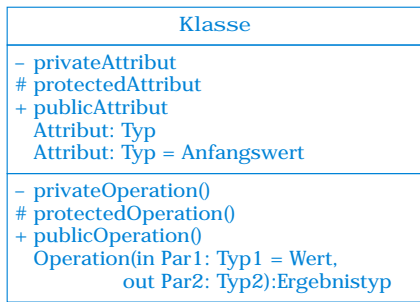
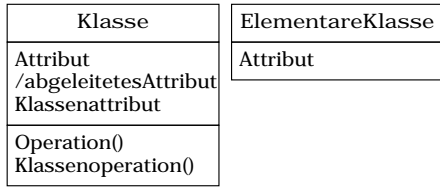
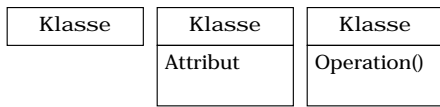

## Vererbung

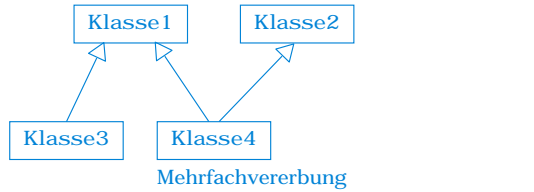
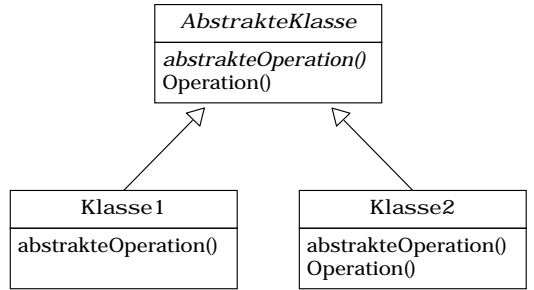
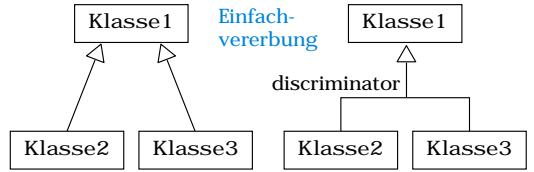

## Paket

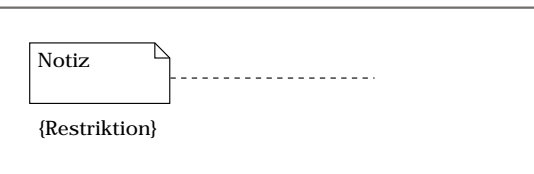
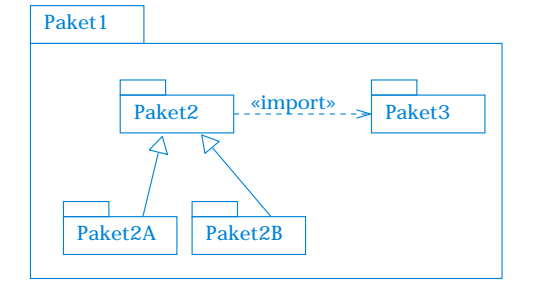

# Assoziation

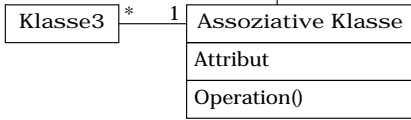
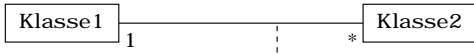
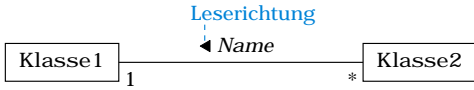
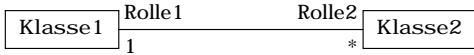

## Qualifizierte Assoziation

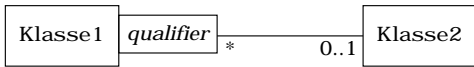

### Kardinalitäten

_____	genau 1
0..1	0 bis 1
*	0 bis viele
3..*	3 bis viele
0..2	0 bis 2
2	genau 2
2, 4, 6	2, 4 oder 6
1..5, 8, 10..*	nicht 6, 7 oder 9

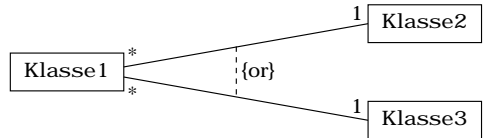

## Aggregation

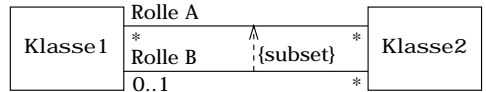
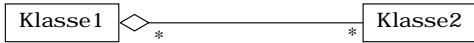

## Komposition

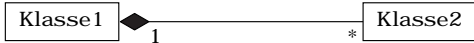

## Navigation

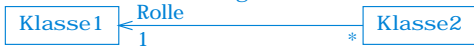

## tertiäre Assoziation

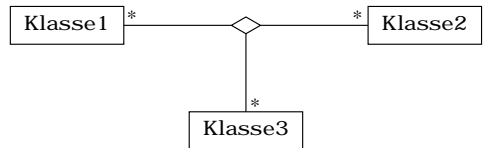

## Abgeleitete Assoziation

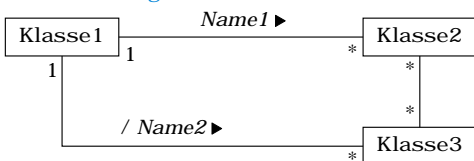

### Geschäftsprozessdiagramm

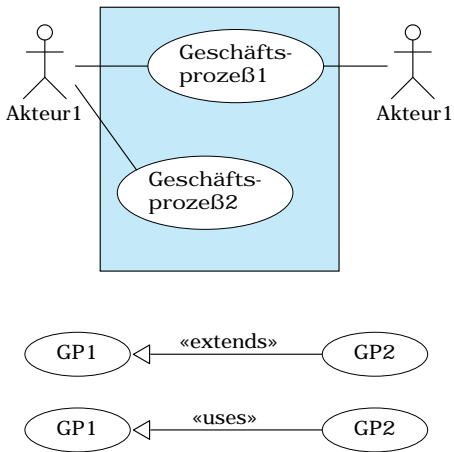

### Zustandsdiagramm

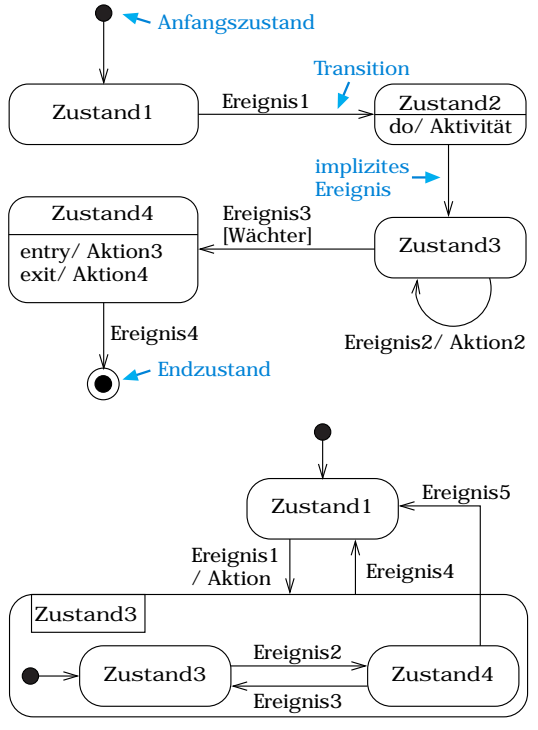

### Aktivitätsdiagramm

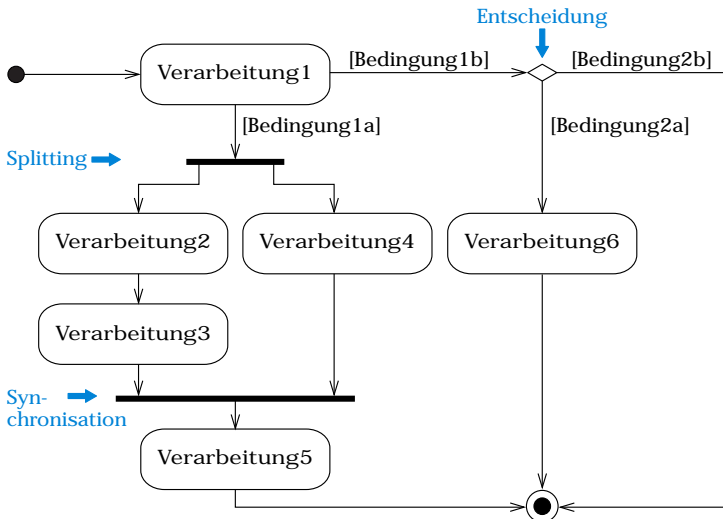

## Sequenzdiagramm

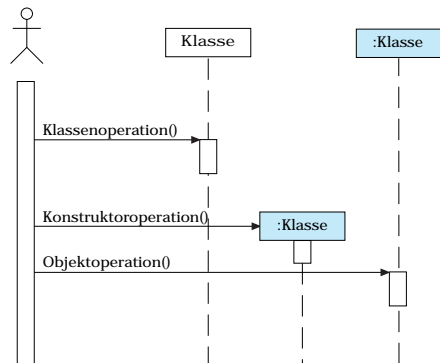
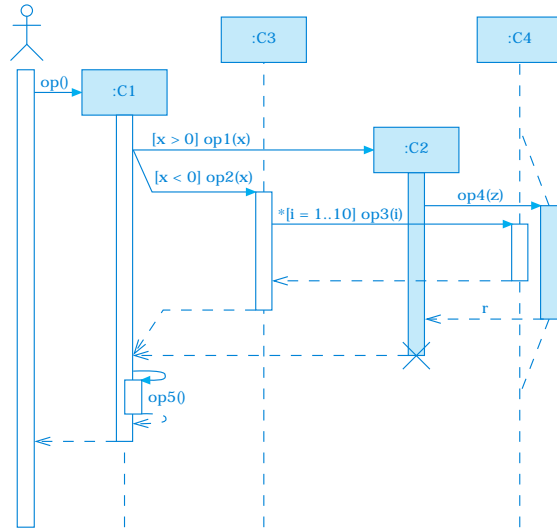
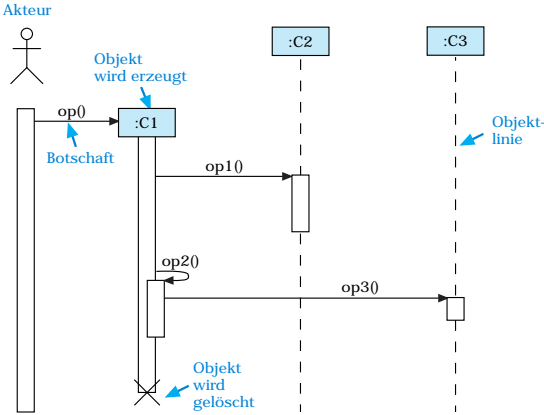

## Kollaborationsdiagramm

